

# FDC15 SERIES

DC / DC Single & Dual Output: 15 Watts



## Features

- 4:1 wide Input range option 9~36V & 18~75V
- Single & Dual outputs
- Industry Standard 2 x 1.6in package
- High efficiency up to 82%
- Regulated output & Short circuit protection
- 1600V isolation
- Five sided continuous copper shield
- Remote ON / OFF- Standard Positive logic
- High operating temperature +85°C
- Fixed switching frequency
- Optional heat sink: **P/N: 7G-0011A**

## Specifications:

<b>Input Voltage</b>	24VDC ( 9 ~ 36 ) 48VDC ( 18 ~ 75 )	<b>Efficiency</b>	Model dependant 80 ~ 82%
<b>Input Filter</b>	Pi type	<b>Isolation</b>	1600VDC
<b>Input Surge Voltage. ( 100mS )</b>	24V: 50VDC. 48V: 100VDC	<b>Isolation Cap.</b>	300pF
<b>Input Reflected Ripple Current</b>	20mA pk-pk ( @ nominal input & 100% load	<b>Switching Freq.</b>	Standard 270KHz
<b>Start Up time</b>	20mS constant resistive load	<b>Safety</b>	EN60950-1, UL60950-1
<b>Remote ON/OFF ( Positive logic )</b>	DC-DC ON Open or 3.5V < Vr < 12V DC-DC OFF Short or 0V < Vr < 1.2V Input current of remote control pin: 0.5mA Remote off state input current: 2.5mA	<b>Case Material</b>	Nickel-coated copper
<b>Output power</b>	15 watts	<b>Base Material</b>	Non-conductive black plastic
<b>Voltage Accuracy</b>	±1.0%	<b>Potting</b>	Epoxy UL94-V0
<b>Voltage Adjustment</b>	±10% by external trim	<b>Dimensions</b>	50.8 x 40.6 x 10.2mm
<b>Minimum Load</b>	See table	<b>Weight</b>	48g
<b>Line Regulation</b>	Single ±0.2% Dual ±0.5%	<b>MTBF</b>	2.041 x 10 <sup>6</sup> Hrs
<b>Load Regulation</b>	Single ±0.5% , Dual ±1% ( Min load -100% load )	<b>Operating Temp</b>	Standard: -45°C to +85°C ( with derating )
<b>Cross Regulation</b>	±5% Asymmetrical load: 25-100% load )	<b>Case Temp</b>	+100°C maximum case temperature
<b>Ripple &amp; noise</b>	See table. 20MHZ bandwidth	<b>Thermal Impedance</b>	10°C / watt Standard convection 8.24°C / watt with optional heatsink
<b>Temp. Coefficient</b>	±0.02% / °C	<b>Thermal shock</b>	MIL-STD-810F
<b>Transient Response</b>	250uS ( 25% load step change )	<b>Vibration</b>	10-55Hz, 10G, 30min along X, Y,Z
<b>Over Voltage Protection</b>	5.0V: 6.2V 12V: 15V 15V: 18V	<b>Humidity</b>	5-95% RH
<b>Overload Protection</b>	Typically 150% of load	<b>EMC</b>	EN55022 Class A Consult office for Class B design
<b>Short Circuit protection</b>	Continuous hiccup mode	<b>ESD</b>	EN61000-4-2
		<b>Radiated Immunity</b>	EN61000-4-3
		<b>Fast Transients</b>	EN61000-4-4
		<b>Surge</b>	EN61000-4-5
		<b>Conducted Immunity</b>	EN61000-4-6

# FDC15 SERIES

DC / DC Single & Dual Output: 15 Watts

Model	Input V	Output V	Output Current		Output Ripple & Noise	Input Current		Eff (%)	Capacitor Load max
			Min. load	Full load		No load	Full load		
FDC15-24S05	9 – 36 V	5 V	210mA	3000mA	75mVp-p	20mA	822mA	80	6800uF
FDC15-24S12	9 – 36 V	12 V	100mA	1250mA	75mVp-p	10mA	801mA	82	890uF
FDC15-24S15	9 – 36 V	15 V	80mA	1000mA	75mVp-p	20mA	801mA	82	570uF
FDC15-24D05	9 – 36 V	± 5 V	± 105mA	± 1500mA	75mVp-p	20mA	822mA	80	± 1700uF
FDC15-24D12	9 – 36 V	± 12 V	± 50mA	± 625mA	75mVp-p	20mA	801mA	82	± 300uF
FDC15-24D15	9 – 36 V	± 15 V	± 40mA	± 500mA	75mVp-p	20mA	801mA	82	± 200uF
FDC15-48S05	18 – 75 V	5 V	210mA	3000mA	75mVp-p	15mA	411mA	80	6800uF
FDC15-48S12	18 – 75 V	12 V	100mA	1250mA	75mVp-p	15mA	401mA	82	890uF
FDC15-48S15	18 – 75 V	15 V	80mA	1000mA	75mVp-p	10mA	401mA	82	570uF
FDC15-48D05	18 – 75 V	± 5 V	± 105mA	± 1500mA	75mVp-p	10mA	411mA	80	± 1700uF
FDC15-48D12	18 – 75 V	± 12 V	± 50mA	± 625mA	75mVp-p	20mA	401mA	82	± 300uF
FDC15-48D15	18 – 75 V	± 15 V	± 40mA	± 500mA	75mVp-p	15mA	401mA	82	± 200uF

Notes:

1. MTBF as per BELLCORE TR-NWT-000332. Case I: 50% Stress, Temperature at 40°C. (Ground fixed and controlled environment).
2. Typical values at nominal input voltage and full load.
3. The output requires a minimum loading on the output to maintain specified regulation. Operation under no-load condition will not damage these devices, however they may not meet all listed specification.
4. The ON/OFF control pin voltage is reference to -Vin.
5. Heat-sink is optional and **P/N: 7G-0011A**.
6. An external filter capacitor is required if the module has to meet EN61000-4-5. The filter capacitor recommended: Nippon chemi-con KY series, 220µF/100V, ESR 48mΩ.

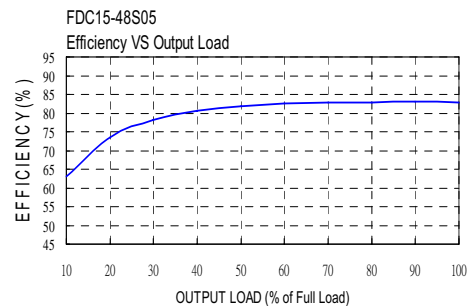
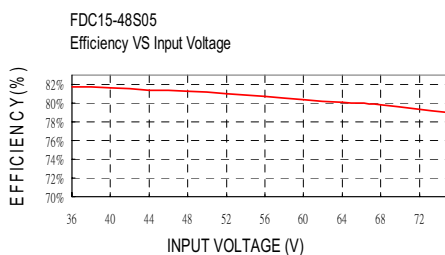
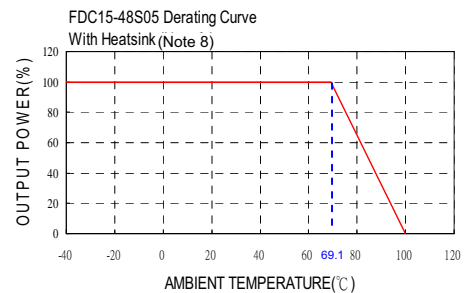
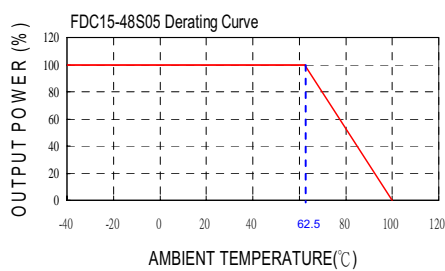

# FDC15 SERIES

DC / DC Single & Dual Output: 15 Watts

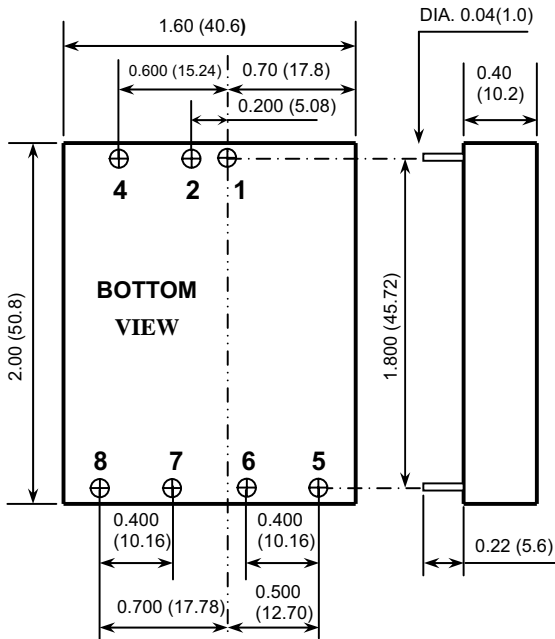

1. All dimensions in Inches (mm)  
Tolerance: X.XX±0.02 (X.X±0.5)  
X.XXX±0.01 (X.XX±0.25)
2. Pin pitch tolerance ±0.01(0.25)
3. Pin dimension tolerance ±0.004 (0.1)

## Pin Assignment

PIN	SINGLE	DUAL
1	+ INPUT	+ INPUT
2	- INPUT	- INPUT
4	CTRL	CTRL
5	NO PIN	+ OUTPUT
6	+ OUTPUT	COMMON
7	- OUTPUT	- OUTPUT
8	TRIM	TRIM

## EXTERNAL OUTPUT TRIMMING

Output can be externally trimmed by using the method shown below.  
( ) for dual output trim

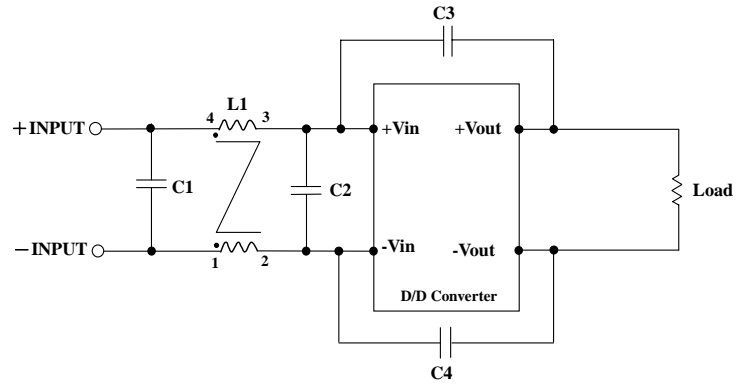
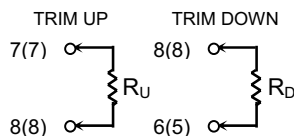

## Recommended Filter for EN55022 Class B Compliance

The components used in the above figure, together with the manufacturers' part numbers for these components, are as follows:

	C1	C2	C3	C4	L1
FDC15-24xxx	6.8uF/50V 1812 MLCC	N/A	1000pF/2KV MLCC	1000pF/2KV MLCC	450uH Common Choke PMT-048
FDC15-48xxx	2.2uF/100V 1812 MLCC	2.2uF/100V 1812 MLCC	1000pF/2KV MLCC	1000pF/2KV MLCC	450uH Common Choke PMT-048

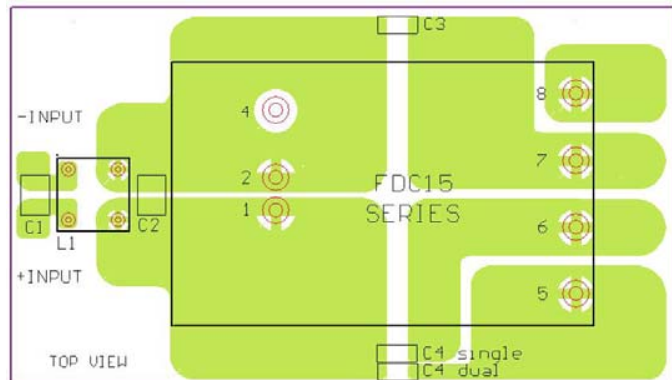

## Recommended EN55022 Class B Filter Circuit Layout